

A18 - Non magnetic

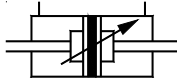

A19 - Magnetic

AIR CYLINDER

Series A18, A19

Cat No A18, A19 - 01 - 01 - C

AIR CYLINDERS Double Acting Double End (Ø125, 160, 200) mm

Features

- Adjustable cushioning at both ends
- Wide varieties of mountings
- Low friction
- Long life
- Optional - High temperature (Viton seals) 150°C max. **
- Optional - Non corrosive Stainless steel piston rod and piston rod lock nut (SS 304) **



Technical Specifications

Cylinder bore Ø	(mm)	125	160	200
Cushion length	(mm)	40	40	40
Standard strokes*	(mm)	50 80 100 125 160 200 250 300 320 400 500		
Medium		Compressed air - filtered - lubricated		
Working pressure		0.5 - 10 bar		
Medium temperature	Regular	5° - 60° C		
	High temperature applications**	5° - 150° C max.		
Materials of construction		Aluminium, Brass, Nitrile, Polyurethane, Steel, Acetal		
Mountings		Basic cylinder, Foot mounting, Flange, Female clevis, Front & Rear trunnion, Centre trunnion		
Accessories		Trunnion bracket, Rod end fork, Rod end spherical eye		

* For Non standard or longer stroke cylinders, contact your regional dealer or **JANATICS**

** Refer Special Ordering number.

Output force (force in N : 1N = 0.1 kgf)

Cylinder Bore Ø (in mm)	Rod Ø (in mm)	Working pressure in bar								
		2	3	4	5	6	7	8	9	10
125	32	2064	3096	4128	5160	6192	7224	8256	9288	10320
160	40	3392	5089	6785	8482	10178	11875	13571	15268	16964
200	40	5428	8143	10857	13571	16286	19000	21714	24429	27143

(Above values have been worked out taking frictional loss into consideration)

AIR CYLINDER

Series A18, A19

Cat No A18, A19 - 01 - 01 - C

Basic cylinder

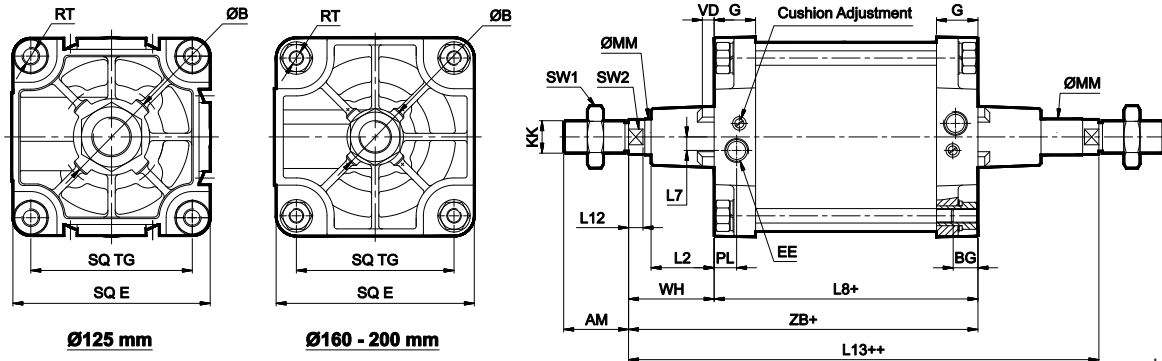

+ Add stroke
++ Add stroke twice

Cylinder bore Ø	KK	AM	MM	SW2	L12	SW1	B e11	VD	L2	E max	G	TG	RT	BG min	EE	PL	L7	WH ±2.2	ZB	ToI	L13 ±2	L8	ToI	Stroke tol
125	M27 x 2	54	32	27	13	41	60	10	48.5	136	44	110	M12	20	G1/2	20	12	65	225	±1.2	292	160	±1	+ 4 0
160	M36 x 2	72	40	36	16	55	65	8	60	183	51	140	M16	24	G3/4	26	15	80	260	±1.5	341	180	±1.1	
200	M36 x 2	72	40	36	16	55	75	8	70	222	46	175	M16	24	G3/4	25	15	95	275	±1.5	372	180	±1.6	

MOUNTINGS FOR AIR CYLINDER Series A18, A19

Foot mounting

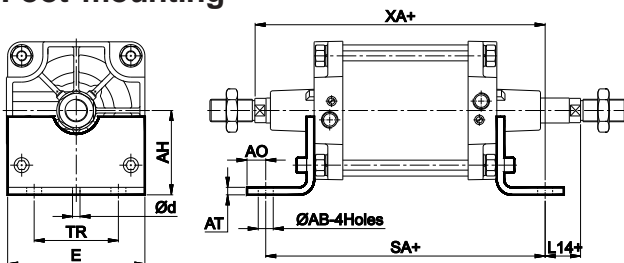

+ Add stroke

Cylinder bore Ø	TR ±0.3	AB H14	AH Js16	AO Max	AT	E	d*	SA ±2	L14 ±2.5	XA ±2	Ordering no.
125	90	16.5	90	17	8	140	11.8	250	22	270	ML0125
160	115	18.5	115	17	10	180	11.8	300	21	320	ML0160
200	135	24	135	30	12	220	11.8	320	27	345	ML0200

* Suitable for reaming

Flange

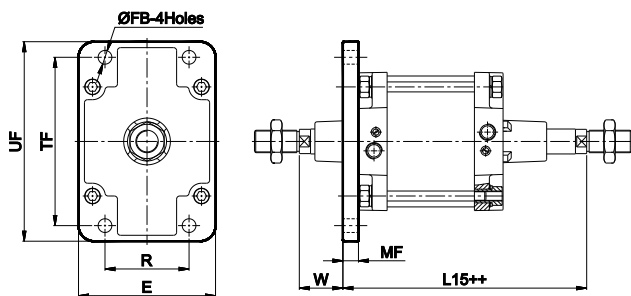

++ Add stroke twice

Cylinder bore Ø	TF ±0.3	R ±0.3	FB H13	MF	UF	E	W ±2.5	L15	ToI	Ordering no.
125	180	90	16	20	211	141	45	247	±2	MF0125
160	230	115	18	20	276	180	60	281	±2.5	MF0160
200	270	135	22	25	320	221	70	302		MF0200

Female clevis

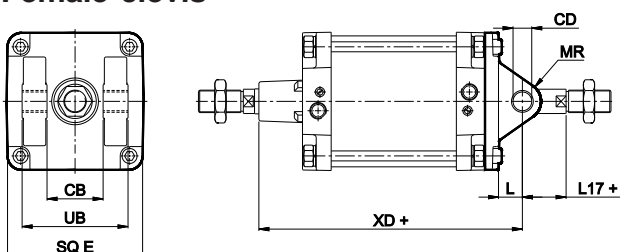

+ Add stroke

Cylinder bore Ø	CD H9	CB H14	L	MR max	UB h14	E max	L17 ±2.5	XD ±2	Ordering no.
125	25	70	30	26	130	140	17	275	MB0125
160	30	90	35	31	170	180	26	315	MB0160
200	30	90	35	31	170	220	37	335	MB0200

AIR CYLINDER

Series A18, A19

Cat No A18, A19 - 01 - 01 - C

Trunnion

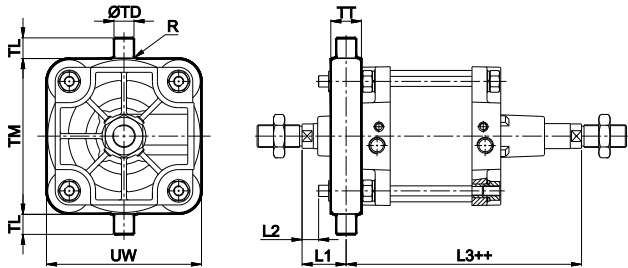

++ Add stroke twice

Cylinder bore Ø	TD e9	TL h14	TM h14	UW	TT	R	L1	L2 Approx	L3 ± 2.5	Ordering no.
125	25	25	160	155	44	2	43	6.5	249	MT0125
160	32	32	200	195	49	2.5	55.5	11.5	285.5	MT0160
200	32	32	250	248	49	2.5	70.5	26.5	301.5	MT0200

Centre trunnion

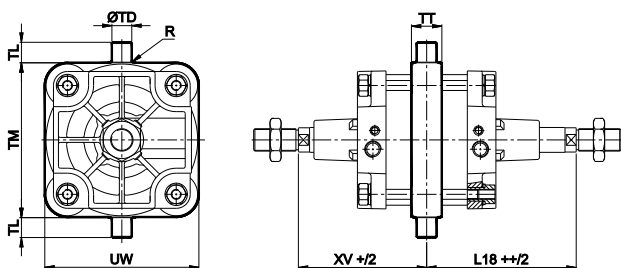

+ Add stroke

++ Add stroke twice

Cylinder bore Ø	TD e9	TL h14	TM h14	UW	TT	R	XV ±2.5	L18 ±2.5
125	25	25	160	155	44	2	145	147
160	32	32	200	195	49	2.5	170	171
200	32	32	250	248	49	2.5	185	187

Note : Cylinder with centre trunnion is factory fitted, please contact JANATICS - H.O

Accessories for Air Cylinder series A18, A19

Trunnion bracket

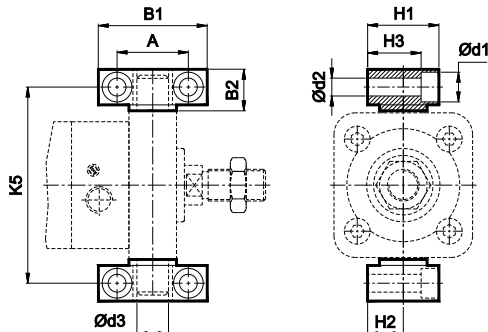

Cylinder bore Ø	B1	B2	A	d1	d2 H13	d3 H9	H1	H2	H3	K5 Js14	Ordering no.
125	75	28.5	50 ±0.2	20	14	25	50	25 ±0.1	37	192	AT100
160	92	40	60 ±0.3	25	18	32	60	30 ±0.2	43	245	AT0160
200	92	40	60 ±0.3	25	18	32	60	30 ±0.2	43	295	AT0160

Rod end Fork (ISO 8140)

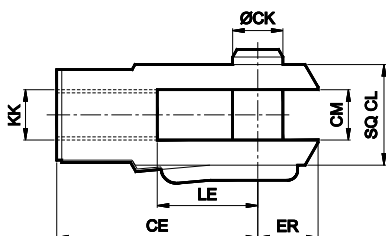

Cylinder bore Ø	KK	CE	CK f 8	CM B12	LE	ER max	CL	Ordering no.
125	M27 x 2	110	30	30	55	45	55	AF030
160 & 200	M36 x 2	144	35	35	72	53	70	AF035

Rod end spherical eye (ISO 8139)

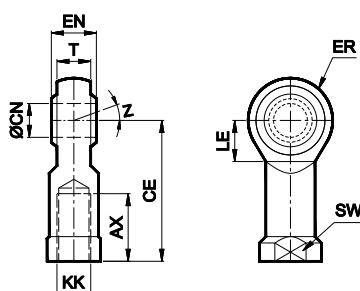

Cylinder bore Ø	KK	CN H9	T	EN h12	CE	LE min	ER max	AX	SW	Z	Ordering no.
125	M27 x 2	30	25	37	110	36	35	51	41	15°	AP027
160 & 200	M36 x 2	35	28	43	125	41	40	56	50		AP036

AIR CYLINDER

Series A18, A19

Cat No A18, A19 - 01 - 01 - C

How to order

A

Model		Piston Ø (mm)		Stroke (mm)		Mountings		Special Cylinders	
18	Standard cylinder	125	- Ø 125	050	- 50	O	- Basic	H	- High temp
19	Magnetic cylinder	160	- Ø 160	080	- 80	L	- Foot Mounting	S	- SS piston rod
		200	- Ø 200	100	- 100	F	- Flange		
				125	- 125	B	- Female Clevis		
				160	- 160	N	- Trunnion		
				200	- 200	T	- Center trunnion		
				250	- 250				
				300	- 300				
				320	- 320				
				400	- 400				
				500	- 500				

Note

For details of Accessories for Magnetic sensor, refer catalogue **Cat No A16, A17 - 01 - 01** (Page no. 1.1.21)

Example :

Ordering no. for magnetic cylinder with 160 dia bore, 100 mm stroke with female clevis mounting with High temp:
A19 160 100 B - H





Note :

If ordered as 40 dia, 50 mm stroke cylinder, Basic cylinder **A18 040 050 O** will be supplied.

For repeat order when the details are taken from cylinder nameplate, mention the mounting style separately.

For ordering **Accessories** refer corresponding tables for ordering numbers.

For ordering individual **Mounting** kits (If needed separately) the order numbers are as below

Cylinder bore Ø	Foot mounting *	Flange *	Female clevis *	Front & Rear trunnion *
				
125	ML0125	MF0125	MB0125	MT0125
160	ML0160	MF0160	MB0160	MT0160
200	ML0200	MF0200	MB0200	MT0200

* Supplied with 4nos. of screws

For your special requirements of cylinders or for further informations contact your regional dealer or **JANATICS**