

# AIR CYLINDER

## Series A03

Cat No A03 - 01 - 03

### COMPACT CYLINDERS MAGNETIC Double Acting ( Ø12 - 100 ) mm

#### Features

- Compact, light weight, and space saving design
- Large clamping force in relation to their size
- Low friction, long life seal design
- Elastomer end cushion

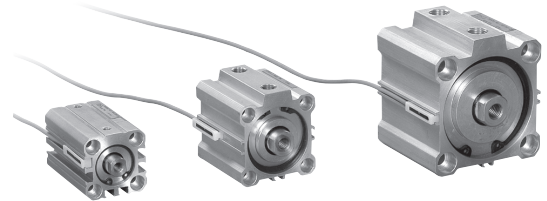

#### Application

These compact cylinders are widely used in low cost automation, SPMs, Industrial machinery, Jigs & fixtures etc.

#### Technical Specifications

Cylinder bore Ø (mm)	12	16	20	25	32	40	50	63	80	100
Standard strokes* (mm)	5, 10, 15, 20, 25, 30, 40		5, 10, 15, 20, 25, 30, 40, 50		5, 10, 15, 20, 25, 30, 40, 50, 60		10, 20, 30, 40, 50, 60, 70, 80			
Medium	Compressed air - filtered - lubricated									
Working pressure range	0.5 - 10 bar									
Medium temperature	5° - 60° C									

\* For Non standard or longer stroke cylinders, contact your regional dealer or **JANATICS**

#### Output force ( force in N : 1N = 0.1 kgf )

Cylinder bore Ø (in mm)	Rod Ø (in mm)		Working pressure in bar								
			2	3	4	5	6	7	8	9	10
12	6	Extend	20	30	40	50	60	70	80	90	100
		Retract	15	22	30	38	46	53	61	68	76
16	8	Extend	36	54	72	90	108	126	144	162	180
		Retract	27	40	54	67	81	95	108	122	135
20	10	Extend	56	84	112	140	169	196	224	254	282
		Retract	42	63	84	106	127	148	169	190	212
25	12	Extend	88	132	176	220	264	308	352	396	440
		Retract	68	102	136	170	204	238	272	306	340
32	16	Extend	145	217	289	362	434	507	579	651	724
		Retract	108	162	217	271	325	380	434	488	542
40	16	Extend	226	339	452	565	678	792	905	1018	1130
		Retract	190	285	380	475	570	665	760	855	950
50	20	Extend	353	530	706	884	1060	1237	1414	1590	1767
		Retract	297	445	594	742	890	1039	1187	1336	1484
63	20	Extend	561	842	1122	1403	1683	1964	2244	2525	2805
		Retract	505	757	1009	1261	1514	1766	2018	2270	2523
80	25	Extend	905	1357	1809	2262	2714	3167	3619	4072	4524
		Retract	816	1225	1633	2041	2449	2857	3266	3674	4082
100	30	Extend	1414	2120	2827	3534	4241	4948	5655	6362	7068
		Retract	1287	1929	2573	3216	3859	4502	5145	5789	6432

( Above values have been worked out taking frictional loss into consideration )

# AIR CYLINDER

## Series A03

Cat No A03 - 01 - 03

### Basic cylinder

Sizes - Ø12, Ø16

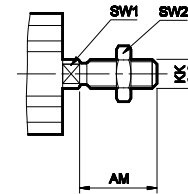
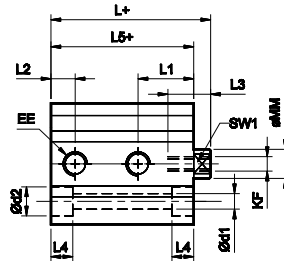
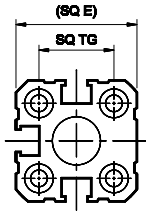

Sizes - Ø20, Ø25

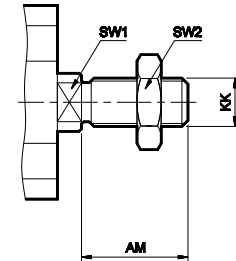
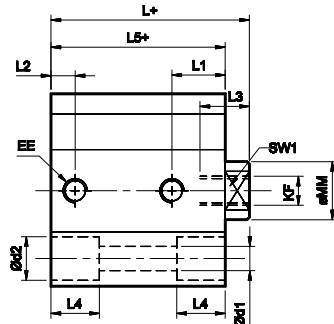
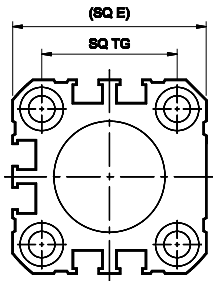

Sizes - Ø32, Ø40, Ø50, Ø63, Ø80, Ø100

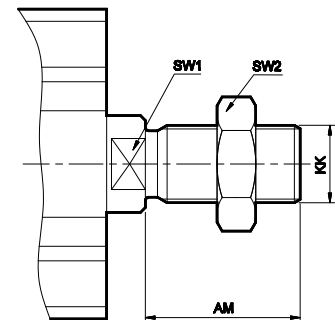
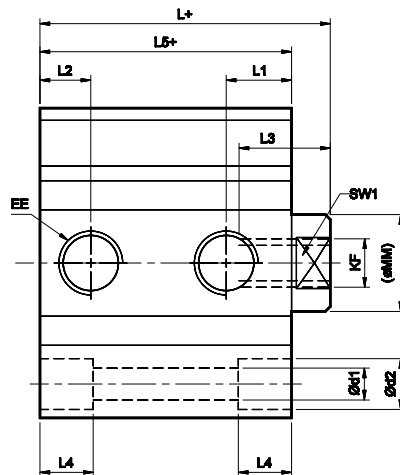
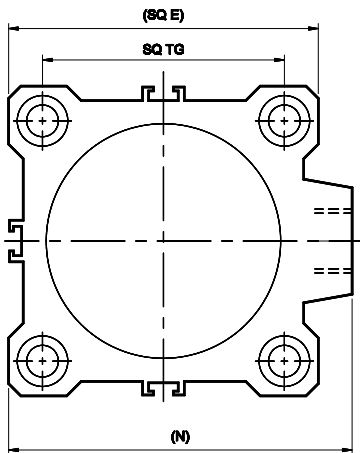

+ Add stroke

Cylinder bore Ø	KF	MM	L3	d1	d2	L4	SW1	L1	L2	EE	TG	E	N	L5	L	KK	AM	SW2
12	M3 x 0.5	6	6	3.5	6	3.5	5	11.5	5	M5 x 0.8	15.5	25	-	33.5	37	M6 x 1	16	10
16	M4 x 0.7	8	8	3.5	6	4.5	6	11	5.5	M5 x 0.8	20	29	-	34.5	38	M8 x 1.25	20	13
20	M5 x 0.8	10	8	5.5	9	9.5	8	11.5	5	M5 x 0.8	25.5	36	-	36.5	40	M10 x 1.25	22	17
25	M6 x 1	12	12	5.5	9	7	10	11	5	M5 x 0.8	28	40	-	39	44	M10 x 1.25	22	17
32	M8 x 1.25	16	13	5.5	9	9	14	12.5	8	G1/8	34	45	49.5	46	53	M12 x 1.25	24	19
40	M8 x 1.25	16	13	5.5	9	9.5	14	11.5	8	G1/8	40	52	57	41.5	48.5	M12 x 1.25	24	19
50	M10 x 1.5	20	15	6.6	10.5	11	17	14	10.5	G1/4	50	64	71	47	55	M16 x 1.5	32	24
63	M10 x 1.5	20	15	9	13.5	10	17	14	10.5	G1/4	60	77	84	48	56	M16 x 1.5	32	24
80	M16 x 2	25	21	11	16.5	13.5	22	18.5	12.5	G3/8	77	98	104	58.5	68.5	M20 x 1.5	40	30
100	M20 x 2.5	30	27	11	16.5	12.5	27	21	12.5	G3/8	94	117	123.5	62.5	73.5	M20 x 1.5	40	30

# AIR CYLINDER

## Series A03

Cat No A03 - 01 - 03

### ACCESSORIES FOR MAGNETIC CYLINDERS Series A03

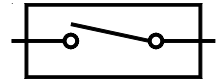

### REED SWITCH

#### Function

The reed switch and clamp assembly is mounted on the Air cylinder (Series A03), for proximity sensing. The piston of the cylinder is equipped with a permanent magnet which activates the reed switch on approaching it. The reed switch closes the circuit giving an electrical signal, which could be used further as required. The accuracy of the sensing distance depends on the speed of operation of the piston.

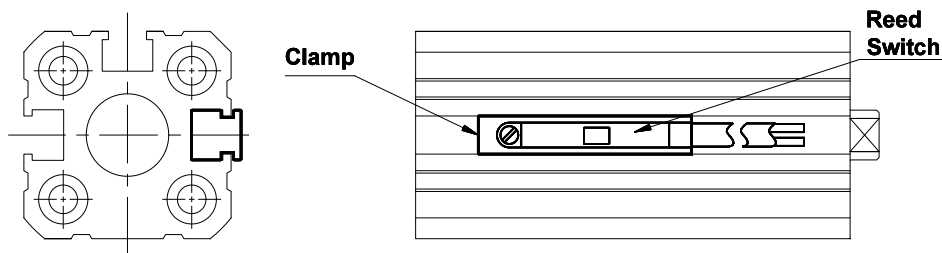

#### Technical Specifications - Reed Switch

Model	<b>AM2012 / AM2032</b>
Suitable cylinder	A03 Series
Operating voltage	5 ~ 120V DC/AC
Switching current	100mA max
Switching rating	6W max.
Voltage drop	3.5V max.
Switching logic	SPST, Normally open
Operating temperature	- 10° to 70° C
Shock	30 G
Vibration	9 G
Type of protection	IEC 529, IP67
Colour of LED	Red
Cable	Ø2.8, 2C, PVC, 2Meter

Bore Dia	Ordering no. for Reed switch & Clamp
Ø12, Ø16, Ø20, Ø 25	AM2012
Ø32, Ø40, Ø50, Ø63, Ø80, Ø100	AM2032

#### Circuit and connect diagram

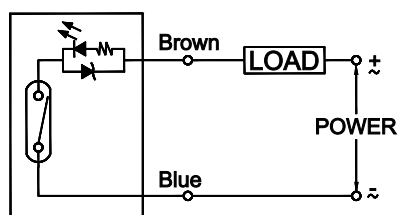

# AIR CYLINDER

## Series A03

Cat No A03 - 01 - 03

### Recommended bolt size for mounting

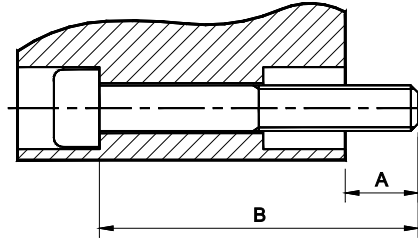

Ordering no.	A	Bolt size B	Ordering no.	A	Bolt size B	Ordering no.	A	Bolt size B	Ordering no.	A	Bolt size B	Ordering no.	A	Bolt size B
A03 012 005	5	M3 x 40	A03 016 005	5	M3 x 40	A03 020 005	8	M5 x 40	A03 025 005	8	M5 x 45	A03 032 005	8	M5 x 50
010	5	x 45	010	5	x 45	010	8	x 45	010	8	x 50	010	8	x 55
015	5	x 50	015	5	x 50	015	8	x 50	015	8	x 55	015	8	x 60
020	5	x 55	020	5	x 55	020	8	x 55	020	8	x 60	020	8	x 65
025	5	x 60	025	5	x 60	025	8	x 60	025	8	x 65	025	8	x 70
030	5	x 65	030	5	x 65	030	8	x 65	030	8	x 70	030	8	x 75
040	5	x 75	040	5	x 75	040	8	x 75	040	8	x 80	040	8	x 85
						050	8	x 85	050	8	x 90	050	8	x 95
												060	8	x 105

Ordering no.	A	Bolt size B	Ordering no.	A	Bolt size B	Ordering no.	A	Bolt size B	Ordering no.	A	Bolt size B	Ordering no.	A	Bolt size B
A03 040 005	8	M5 x 45	A03 050 010	9	M6 x 55	A03 063 010	12	M8 x 60	A03 080 010	15	M10 x 70	A03 100 010	15	M10 x 75
010	8	x 50	020	9	x 65	020	12	x 70	020	15	x 80	020	15	x 85
015	8	x 55	030	9	x 75	030	12	x 80	030	15	x 90	030	15	x 95
020	8	x 60	040	9	x 85	040	12	x 90	040	15	x 100	040	15	x 105
025	8	x 65	050	9	x 95	050	12	x 100	050	15	x 110	050	15	x 115
030	8	x 70	060	9	x 105	060	12	x 110	060	15	x 120	060	15	x 125
040	8	x 80	070	9	x 115	070	12	x 120	070	15	x 130	070	15	x 135
050	8	x 90	080	9	x 125	080	12	x 130	080	15	x 140	080	15	x 145
060	8	x 100												

\* For piston Ø12 to Ø25 use only non magnetic Stainless Steel bolt.

### How to order

A03

○ ○ ○

Piston Ø (mm)	
012	- Ø 12
016	- Ø 16
020	- Ø 20
025	- Ø 25
032	- Ø 32
040	- Ø 40
050	- Ø 50
063	- Ø 63
080	- Ø 80
100	- Ø 100

○ ○ ○

Stroke (mm)	
005	- 5
010	- 10
015	- 15
020	- 20
025	- 25
030	- 30
040	- 40
050	- 50
060	- 60
070	- 70
080	- 80

○ —

O - Basic
-----------

○

M - Male thread
-----------------

### Example:

Ordering no. for cylinder with 40 dia bore, 50 mm stroke with Female thread : **A03 040 050 O**

Ordering no. for cylinder with 40 dia bore, 50 mm stroke with Male thread : **A03 040 050 O - M**

For your special requirements of cylinders or for further informations contact your regional dealer or **JANATICS**

Subject to change